

# BENÖTIGTE MATERIALIEN:



1x STIFT



1x CUTTER-  
MESSER



1x LINEAL



1x PINSEL

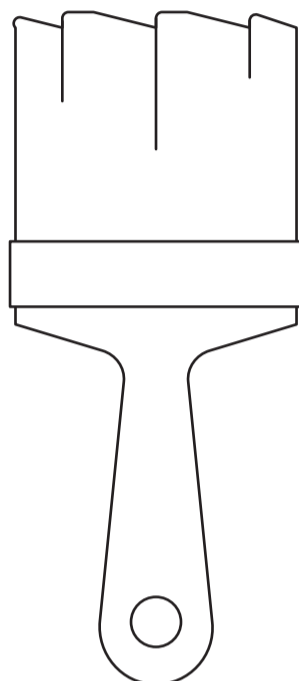

1x TESA EXTRA POWER® UNIVERSAL

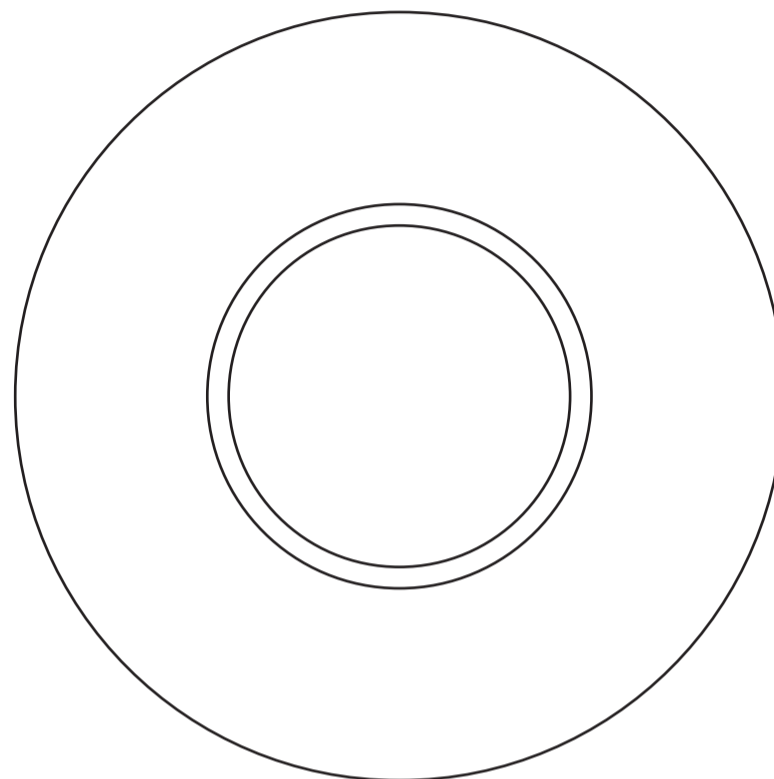

1x SCHNEIDEMATTE

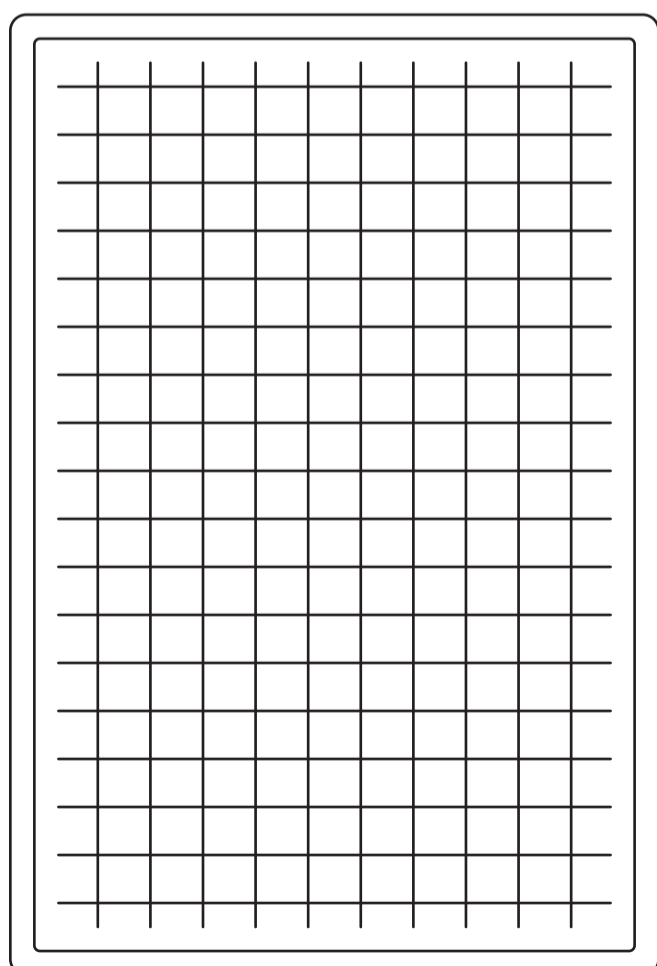

DOPPELWELLIGER PAPPKARTON

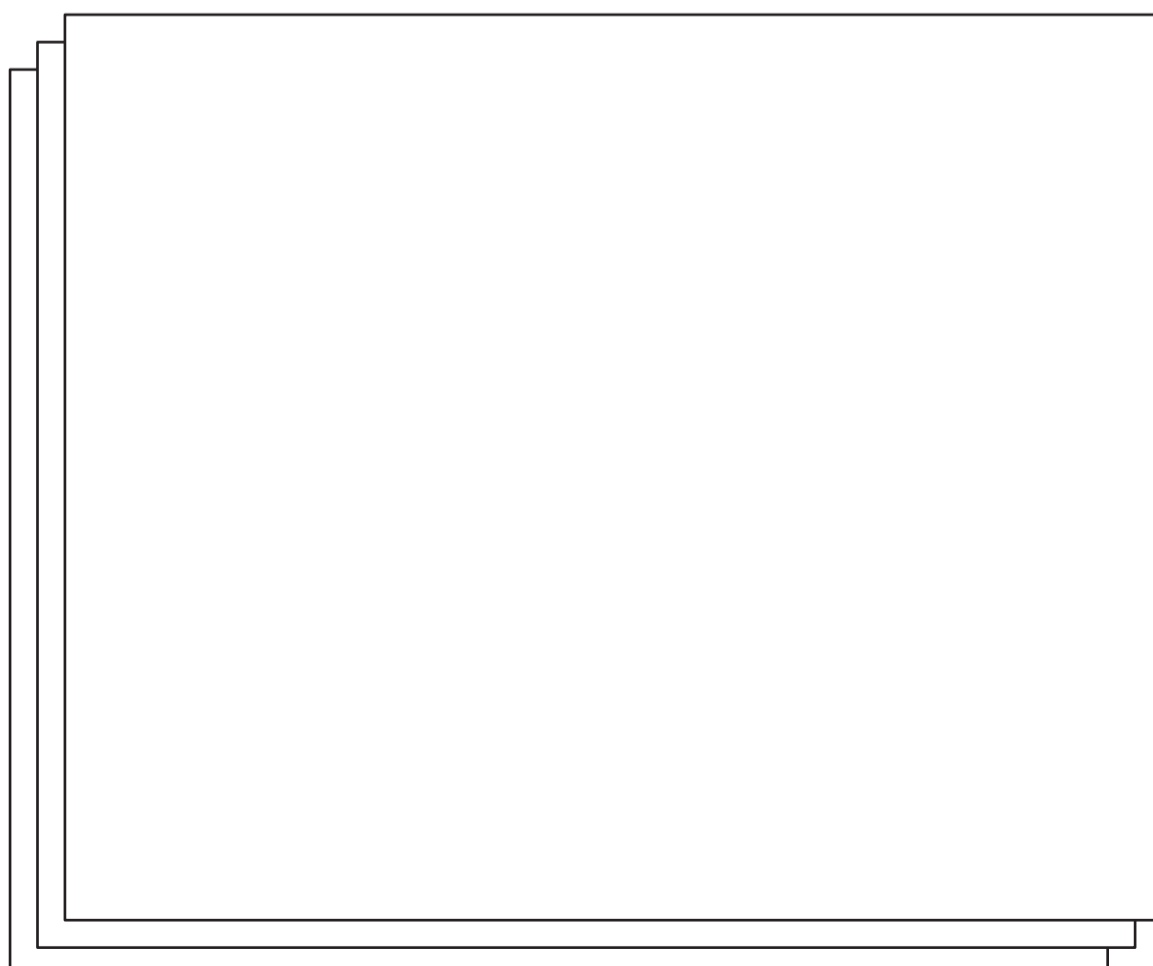

# GRÖSSERER HUND, GRÖSSERE HÜTTE!



ACHTUNG! Dieser Vorlagenbogen ist als A3-Ausdruck angelegt!

In dieser Bauanleitung rechnen wir mit Maßen für eine Hundehütte von 90 cm Durchmesser. Wenn Ihr Hund eine größere Hundehütte benötigt, können Sie sich an folgenden Maßen orientieren:

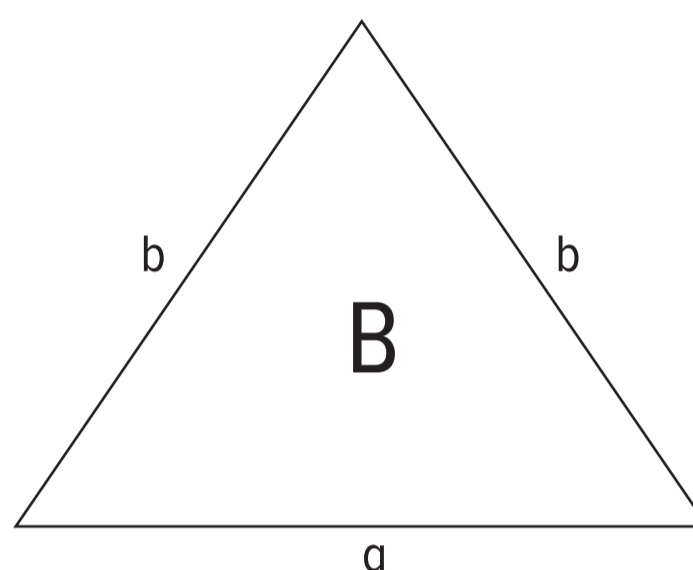
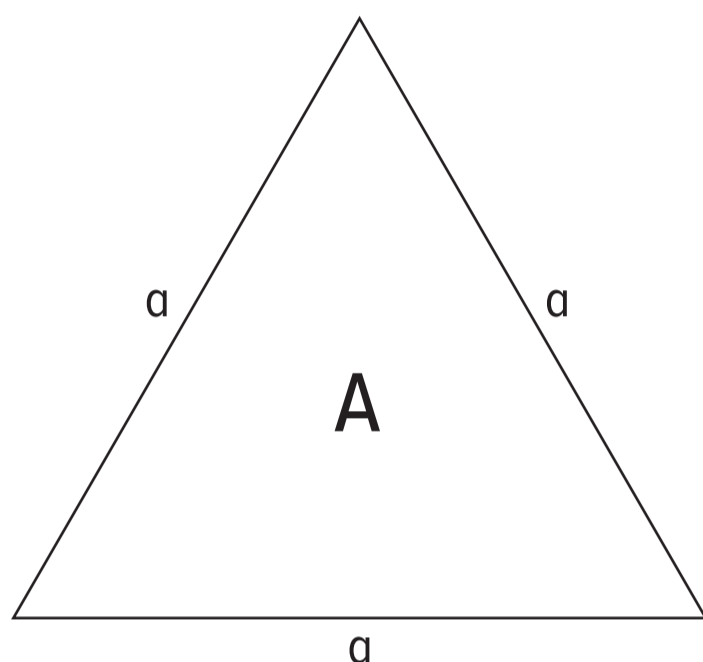

Für eine Hundehütte von 120 cm Durchmesser:  
a 37,08 cm; b 32,79 cm

Für eine Hundehütte von 150 cm Durchmesser:  
a 46,35 cm; b 40,99 cm

SCHNEIDE-VORLAGEN FÜR EINE  
90 CM (DURCHMESSER) HÜTTE:



10x

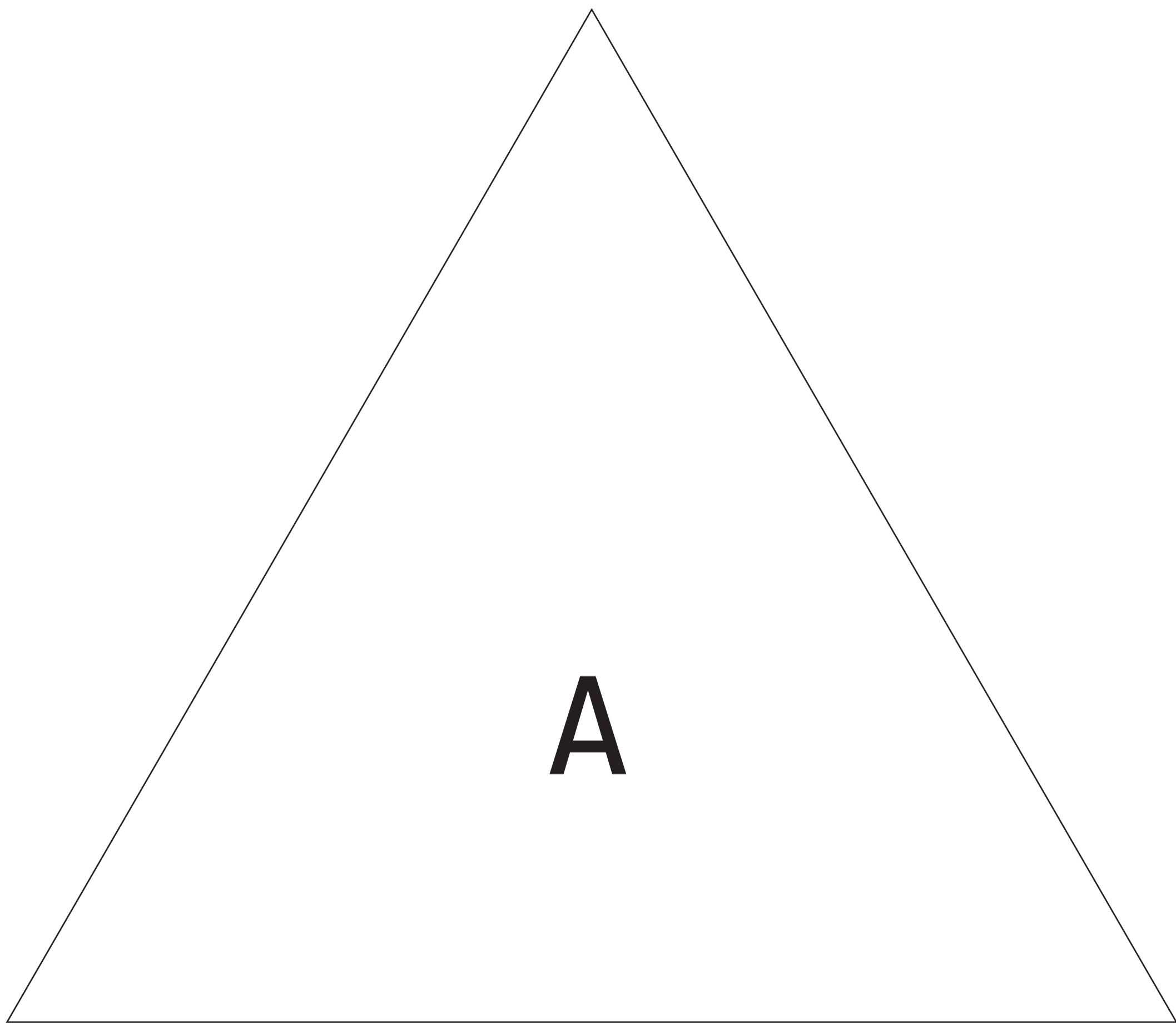

SCHNEIDE-VORLAGEN FÜR EINE  
90 CM (DURCHMESSER) HÜTTE:



25x

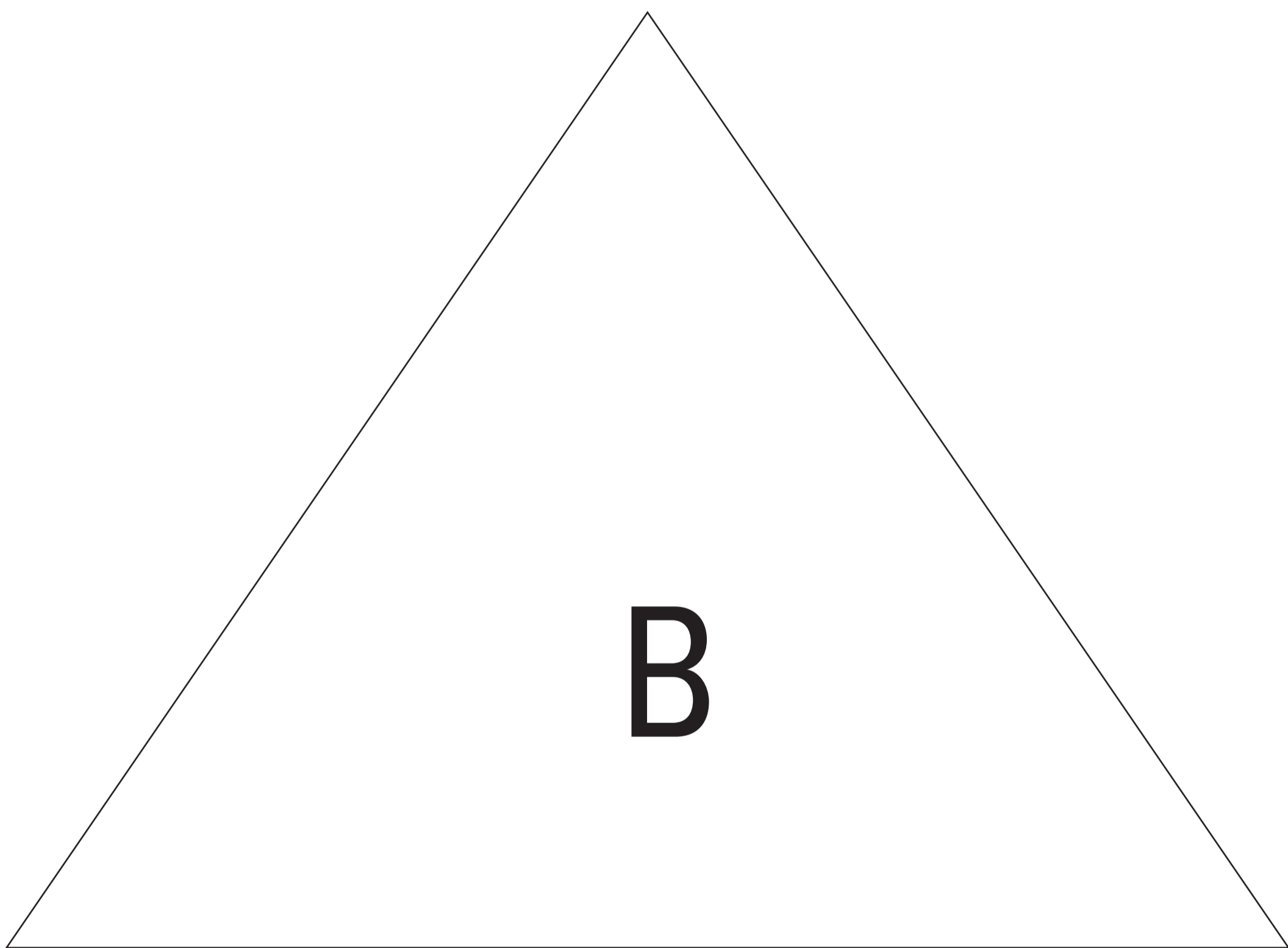

1.

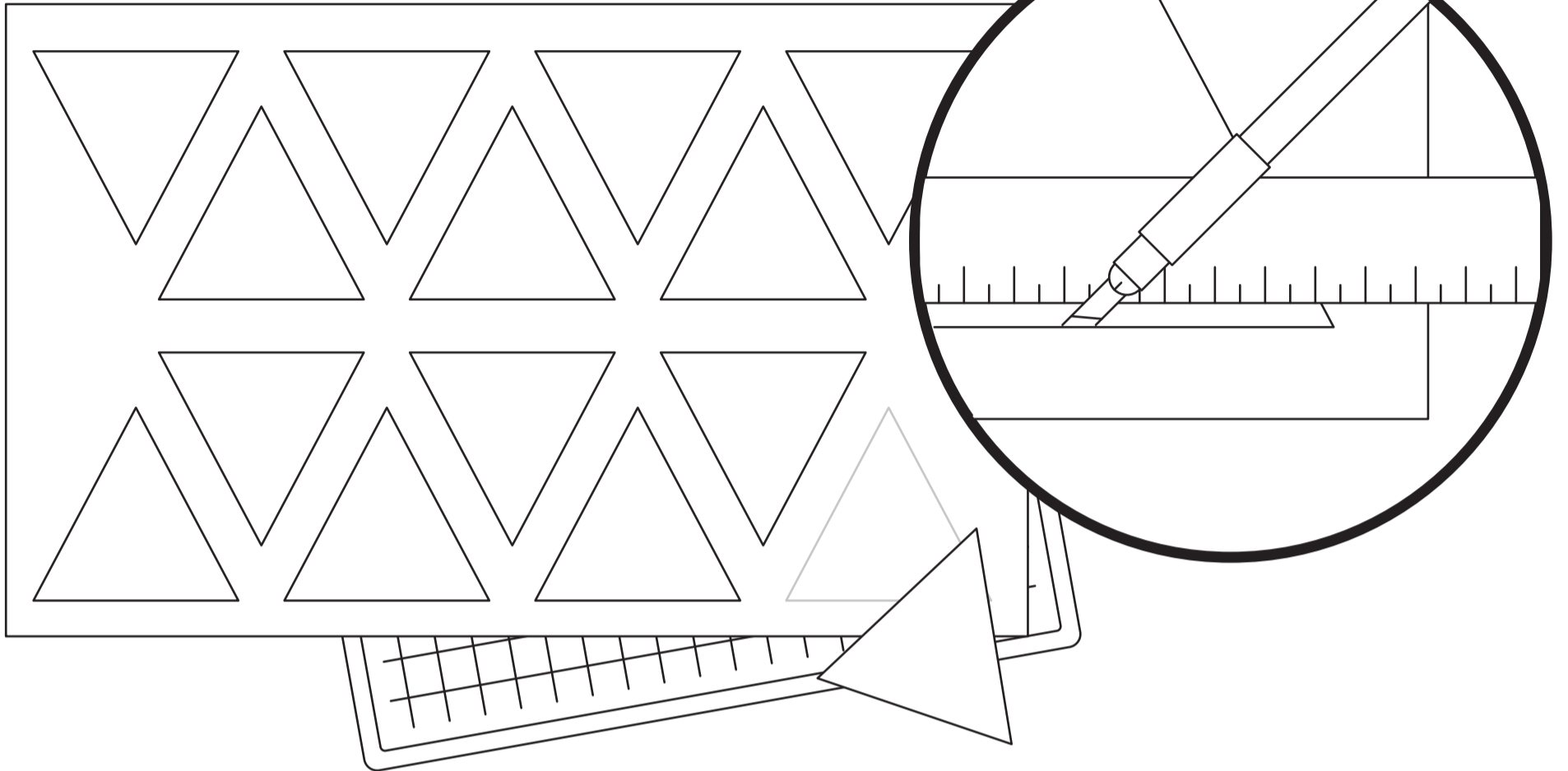

2.

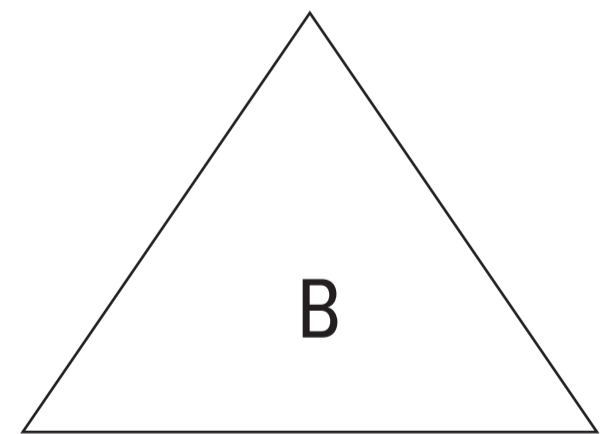
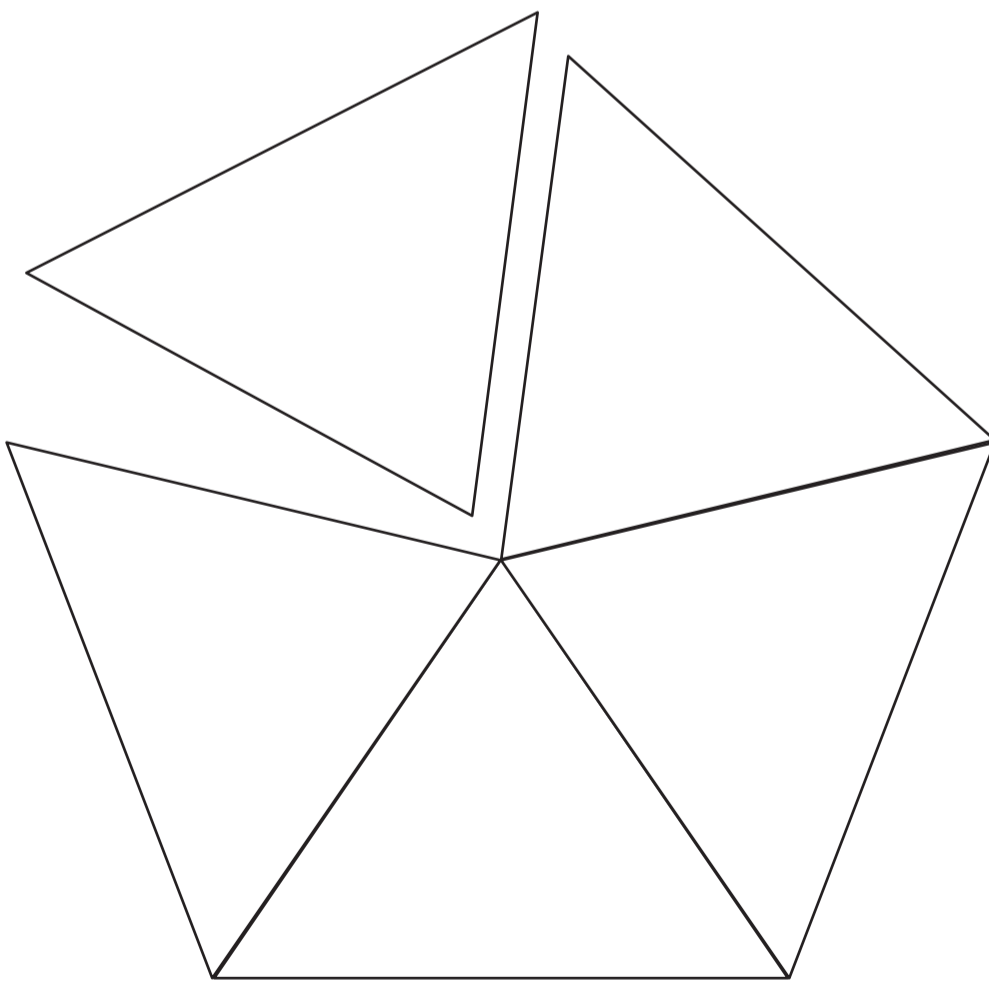

5x B-PANEL

3.

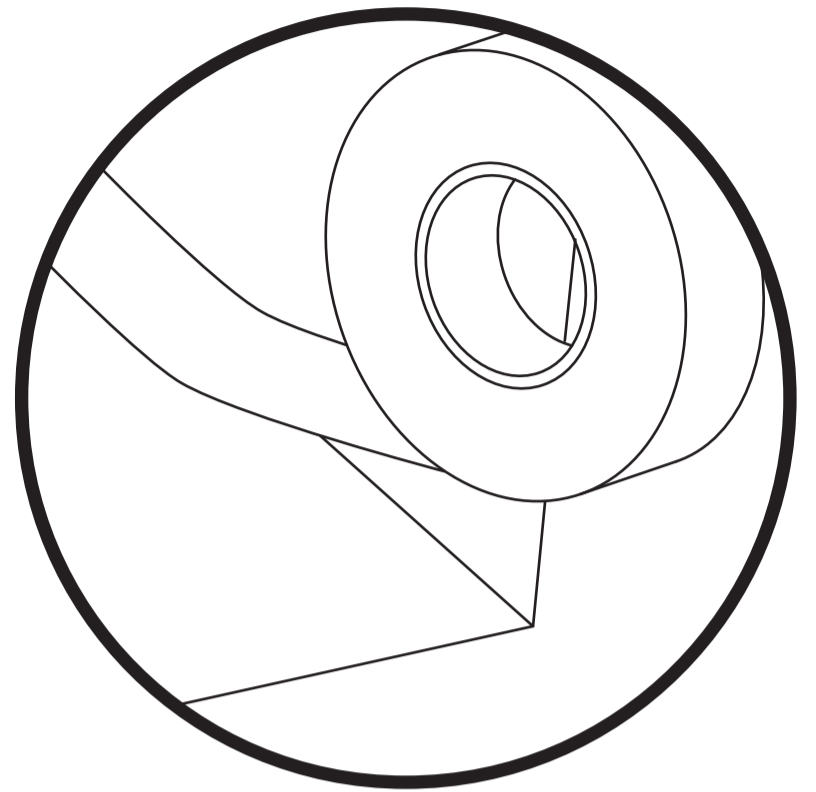
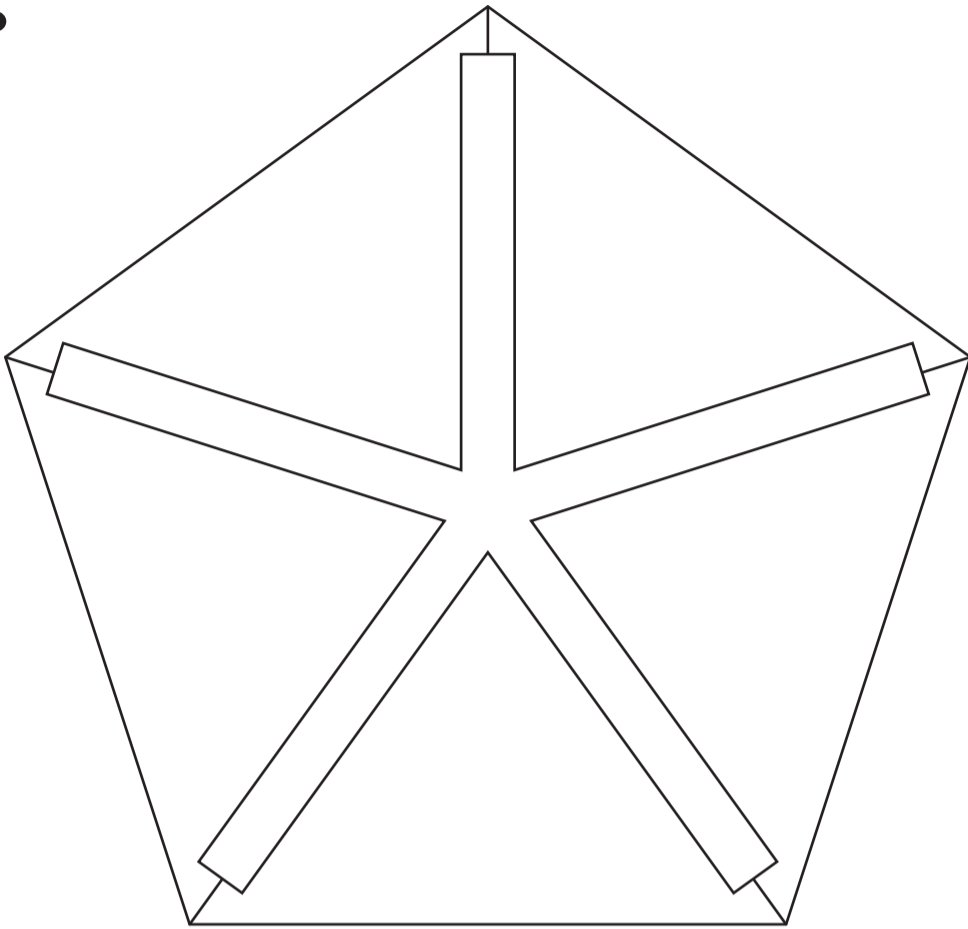

4.

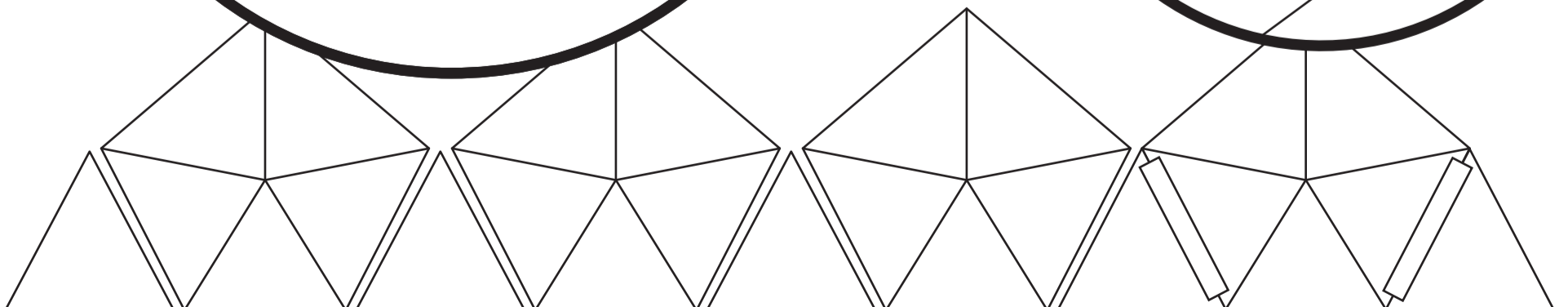
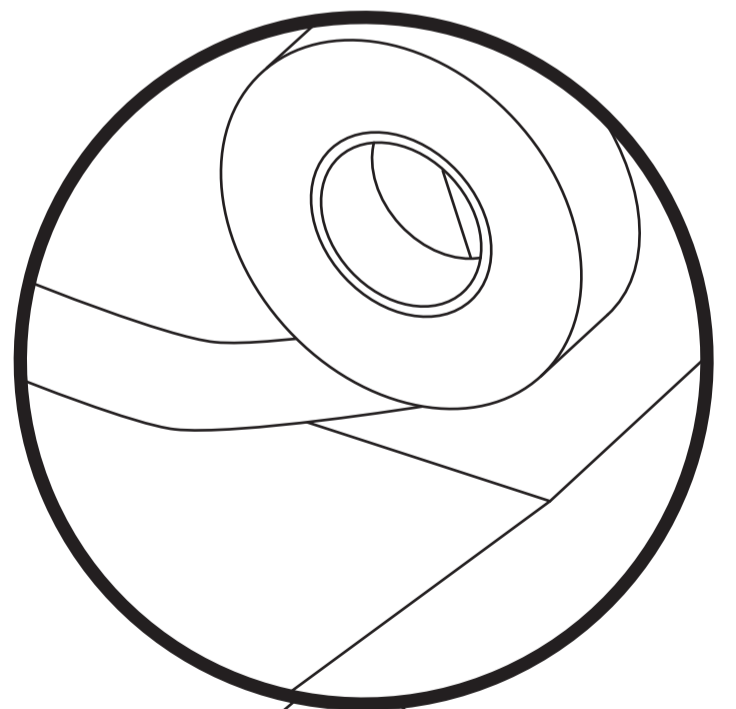
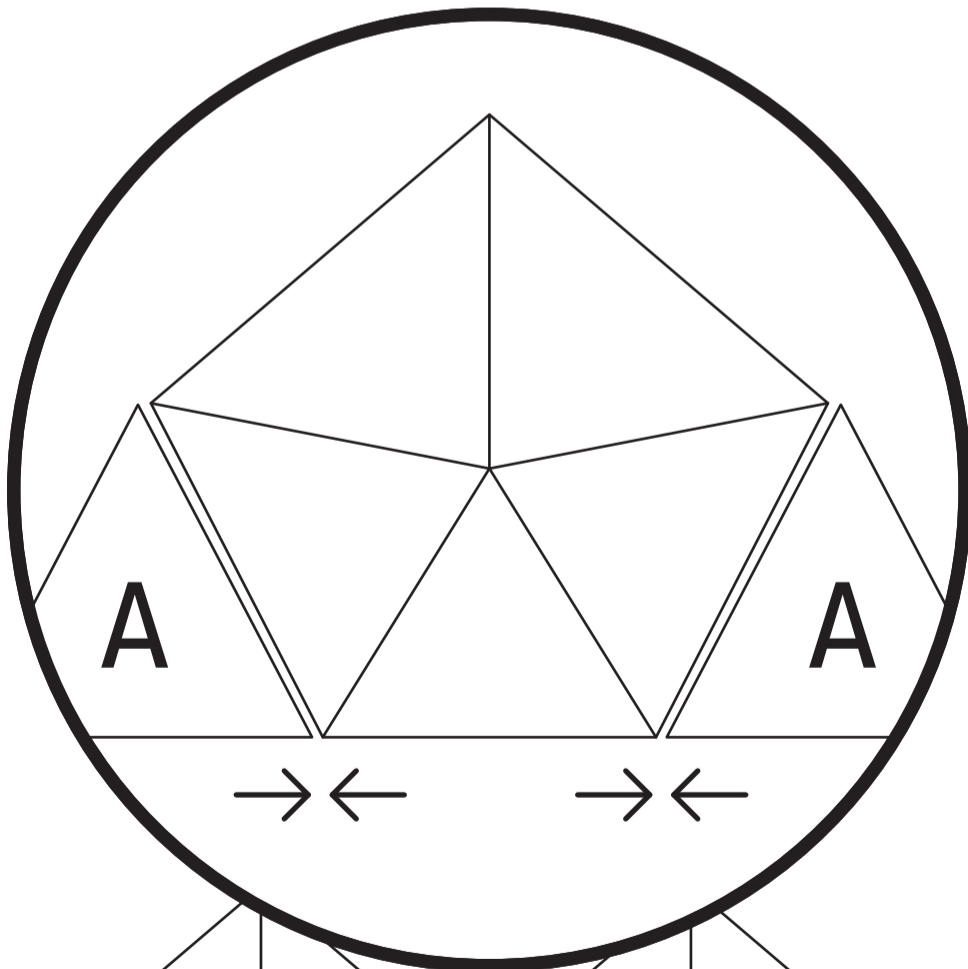

5.

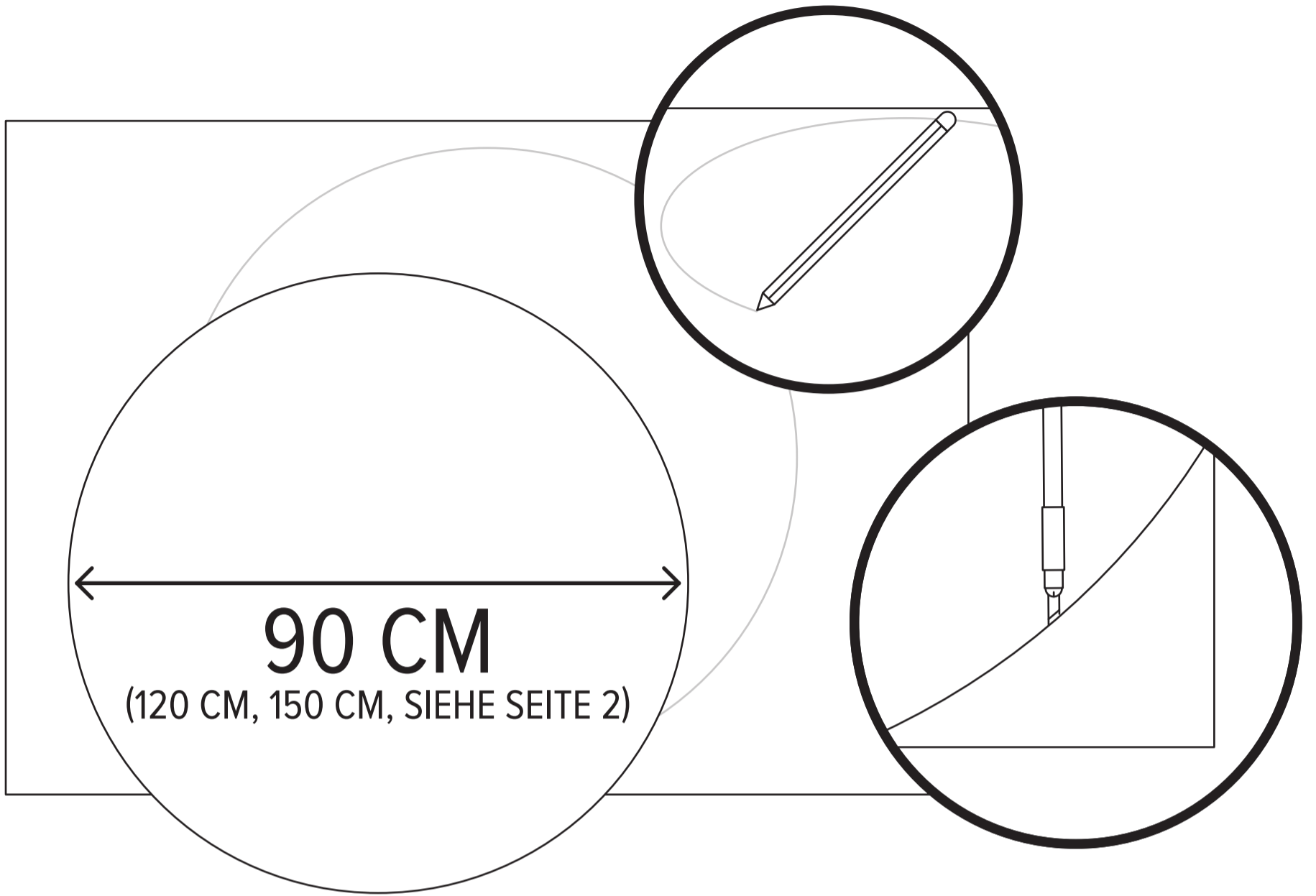

6.

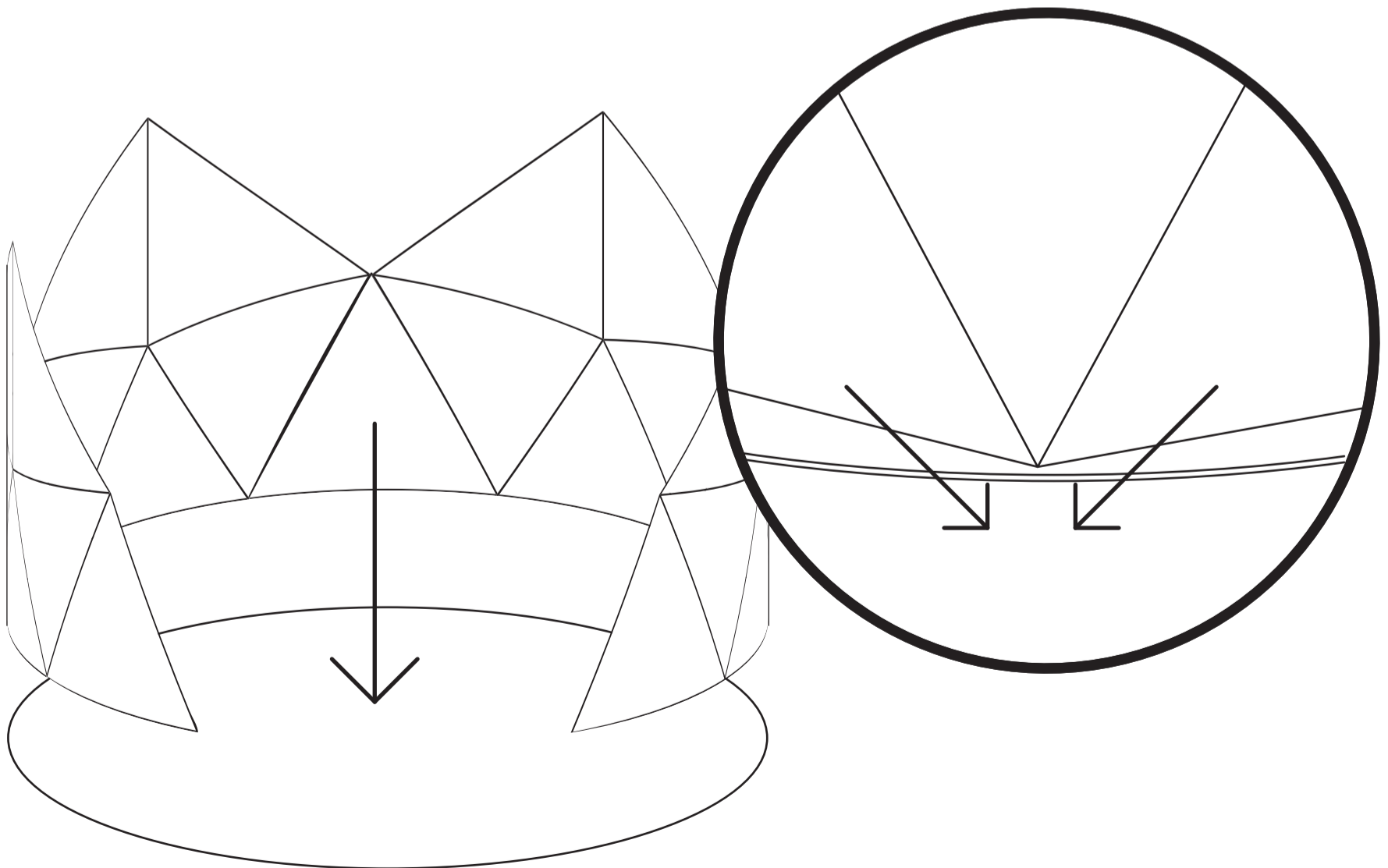

7.

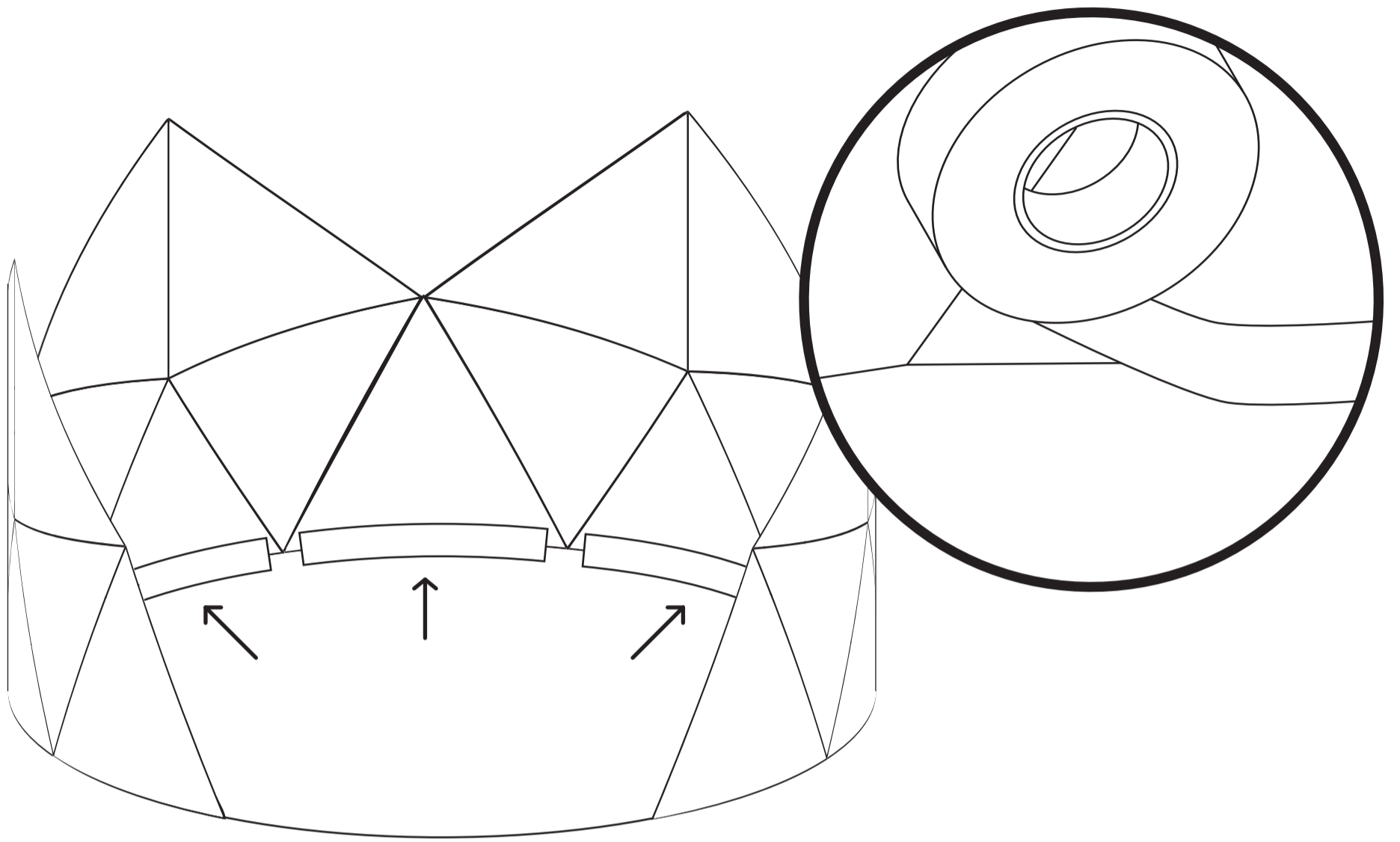

8.

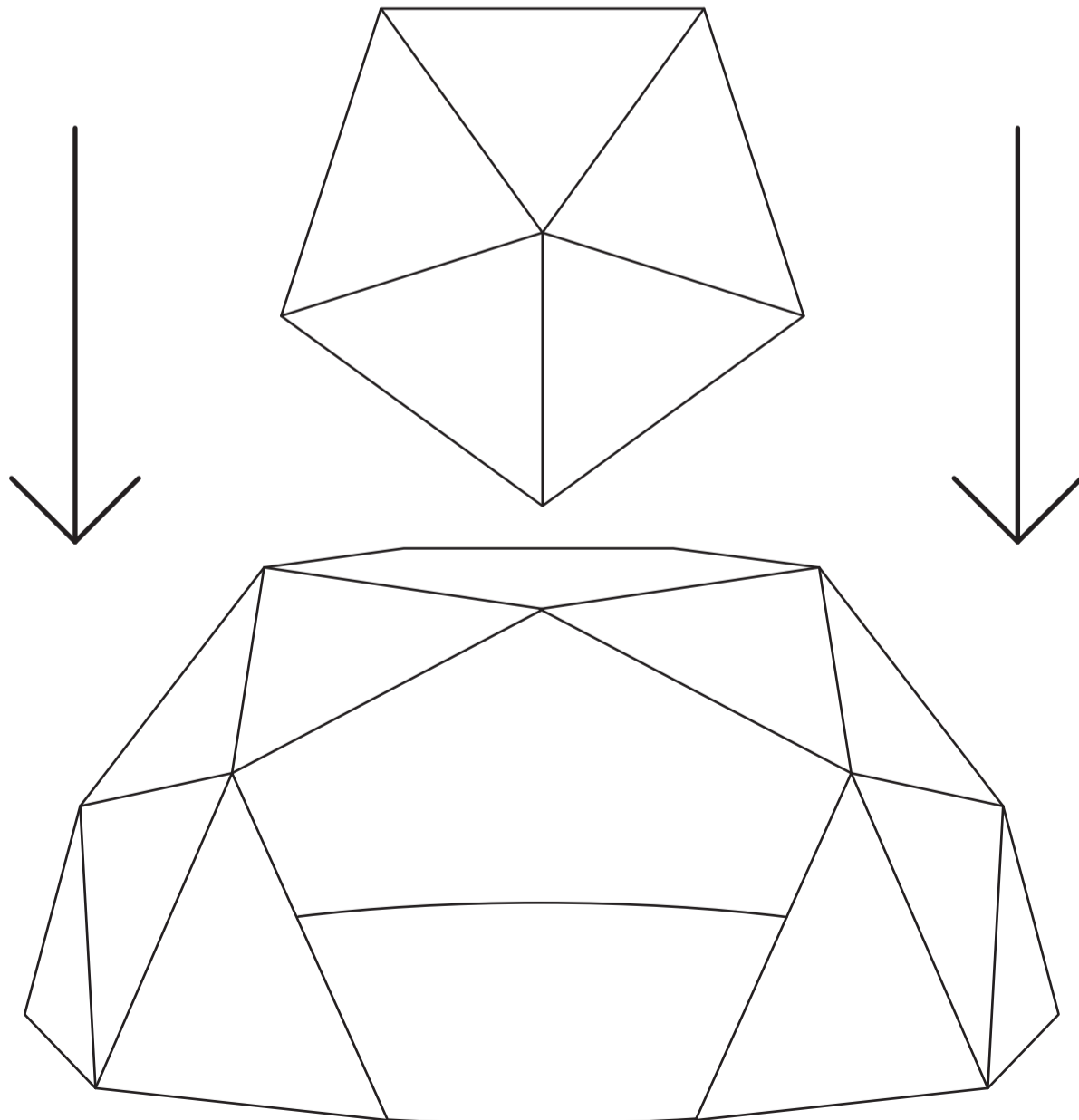



9.

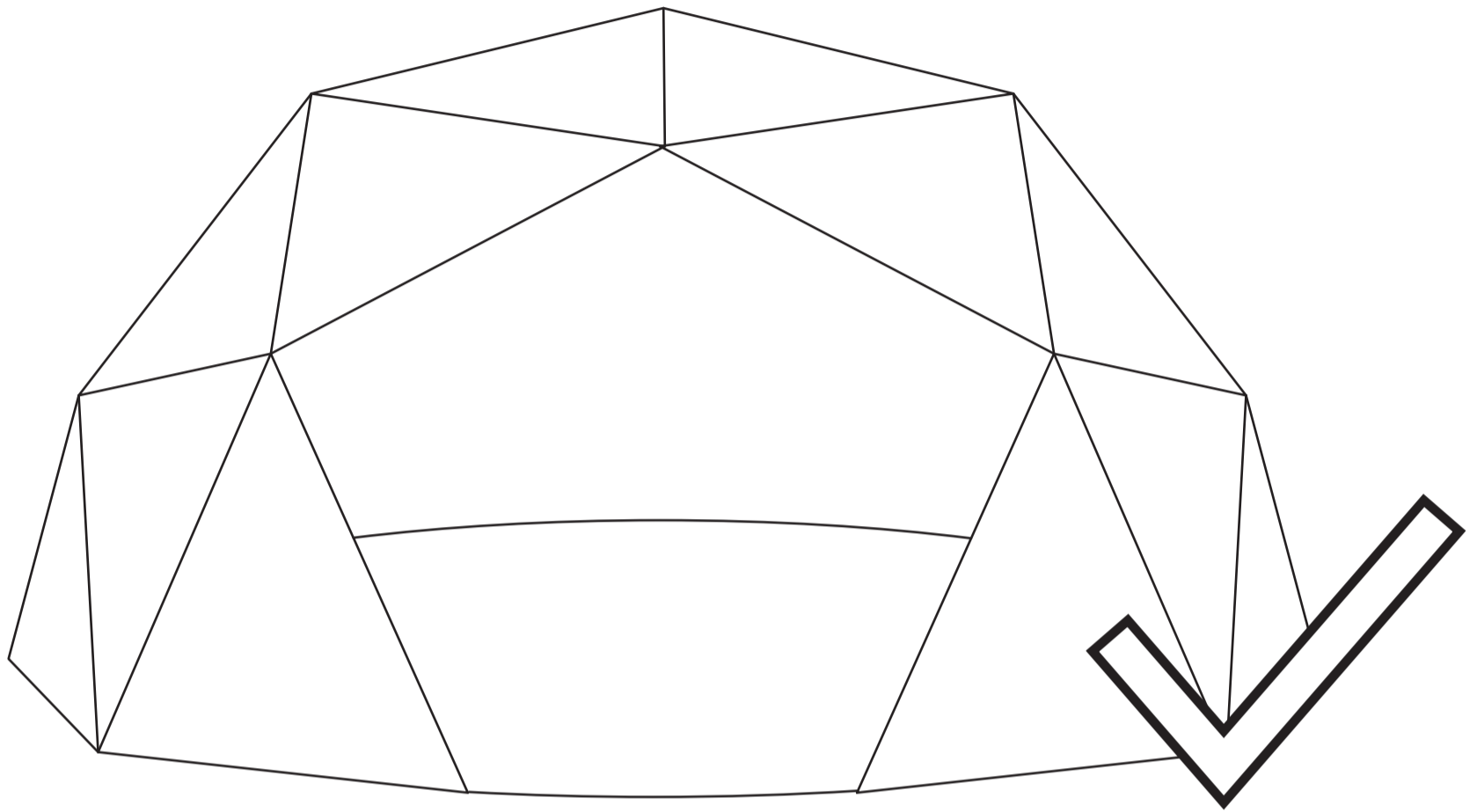

10.

